

## PLANTS

### Toyohashi Plant



150, Motoyashiki, Mitsuya-cho Aza, Toyohashi, Aichi, Japan  
Area: 229,479m<sup>2</sup>  
Opened: June 1965

#### Main Products:

Infrastructure systems (industrial infrastructure, civil infrastructure and small scale smart grid systems), semiconductor/clean transport equipment, automotive testing systems, vibrating conveyor systems, parts feeders, electronic devices, and computer controllers.

### SINFONIA GROUP SINFONIA TECHNOLOGY (THAILAND) CO., LTD.



406 Moo 2 Bangpoo Industrial Estate (Soi 2 c) Sukhumvit Road  
Tambol Bangpoomai, Amphur Muangsamutprakarn,  
Samutprakarn, Thailand 10280  
Area: 15,000m<sup>2</sup>  
Opened: June 1989

#### Main Products:

General fabrication of parts feeders, and manufacturing of non-processed bowls/Vibrating equipment/  
Various controllers for construction machinery/  
Clean transport equipment

On July 2008, SINFONIA TECHNOLOGY (THAILAND) CO., LTD. changed its name from THAI PARTS FEEDER CO., LTD.

 For safe and reliable operation, it is essential to read the user's manual carefully before using this equipment.

We have a new slogan in Japan; "ECOing" a combination of "eco" and "ing". This is to promote eco-friendly technological development and manufacturing. Our ecological activities are of course not limited to Japan and practiced in many countries around the world.

## SINFONIA SINFONIA TECHNOLOGY CO., LTD.

Shiba NBF Tower, 1-30, Shibadaimon 1-chome, Minato-ku, Tokyo, 105-8564, Japan  
TEL +81-3-5473-1864 FAX +81-3-5473-1845

### SINFONIA TECHNOLOGY (THAILAND) CO., LTD. Bangkok Sales Office

12th Floor Room 1205, 319 Chamchuri Square Building, Phayathai Road, Pathumwan Bangkok Bangkok 10330  
TEL +66-2160-5068 FAX +66-2160-5069

### SINFONIA TECHNOLOGY (SINGAPORE) PTE. LTD.

96 Robinson Road, #13-02 SIF Building, Singapore 068899  
TEL +65-6223-6122 FAX +65-6225-2729

### PT. SINFONIA TECHNOLOGY INDONESIA

Graha Paramita 8th Floor Suite E Jl. Denpasar Raya Block D2 KAV. 8 Kuningan, Jakarta 12940 Indonesia  
TEL +62-21-252-3606 FAX +62-21-252-3608

CODE E90-003 Content of this catalogue may change due to product improvement without notice. URL <http://www.sinfo-t.jp/eng> Printed in Japan 2016 08CIII ©

# Vibrating Equipment General Product Catalogue





Vibration is all around. We see it as ripples on the surface of water and hear it as sound transmitted through the air.

By harnessing the power latent in vibration, vibrating equipment can be used to convey and supply particulate materials and small parts in a wide range of production processes. In such diverse fields as food processing, chemicals, feedstuffs, iron and steel, electronic components and ceramics, vibrating equipment play significant parts in boosting productivity, raising quality and reducing costs. And the challenge continues. New technology is called for to guarantee the steady, reliable delivery of ever more minute and complex components in ever more efficient processes.

SINFONIA produces various types of vibrating equipment. Vibrating conveyors are essential to the production of food and pharmaceuticals, important for human health. Vibrating screens are used for sifting and sorting soils and wastes. Parts feeders supply computer chips and other tiny electronic parts in equipment assembly. These devices have evolved together with the industrial processes they serve.



**A diverse range of vibrating equipment backed by our own vibrating technology, used for everything from particulate materials processing to ultra small parts delivery. Wide-ranging applications support to develop various industry.**



We are widely renowned as a leading manufacturer, and our history in the field goes back more than 60 years. Expertise drawn from our own R&D resources underpins the outstanding performance of equipment we have supplied in the food processing, chemicals, sanitary porcelain and new materials fields. As Japanese industrial might has expanded, we too have grown and evolved. Our many years of experience are now directed towards developing more sophisticated high frequency parts feeders for electronics applications in the IT industry. We also have a long and successful record in the production of processing system installations centered on vibrating equipment.

In other new ventures we are developing unique equipment that borrows technology from other fields, and vibratory technology that minimizes its effect on the surrounding environment. An example is the world's first sliding conveyor based on horizontal vibration powered by an HD motor. This revolutionary new product is attracting attention as it creates no noise or unwelcome vibration.

In the production of a versatile range of equipment and research into new technology, we are constantly looking ahead in our quest to maximize the potential of vibratory equipment.

**Principle of conveyance by vibrating devices**

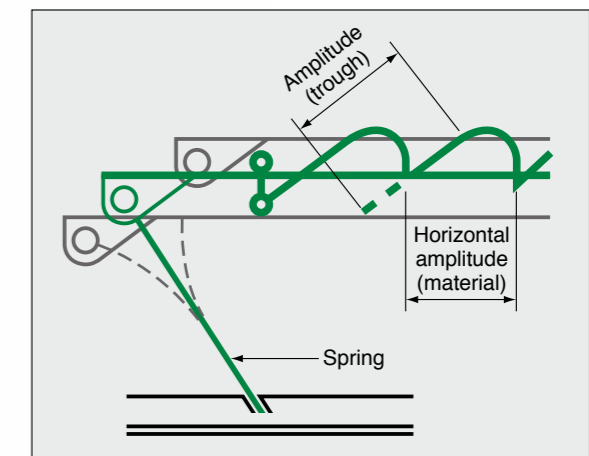

- 1 Vibration causes trough to shift to lower left.
- 2 Speed of shift causes material in trough to fall forward.
- 3 Trough shifts to upper right to return to original position.
- 4 Material is also thrown up and forward.
- 5 This process is repeated.

The material is tossed in this way in a direction that is at right angles to the alignment of the equipment's spring.



# VIBRATING CONVEYORS

## A wide range of models, from the conventional to the uniques

High-performance vibrating conveyors transfer powdered or granular materials by means of an appropriate type and level of vibration, while processing such as drying, cooling, sorting, cleaning or draining takes place. Comprising many types of trough and powerful vibrating generators, our comprehensive product line-up offers conventional models as well as exciting new types utilizing horizontal vibration. Their notable features include vibro-isolating construction that stops transmission of the vibration to the floor, low noise, and easily adjustable vibratory characteristics. They offer new means of conveyance for the efficient processing of all sorts of particulate materials: foodstuffs, chemicals, pharmaceuticals, fertilizers, glass, cement, mineral ores and coal, and contribute to the streamlining and productivity of material processing lines.



Spiral elevator

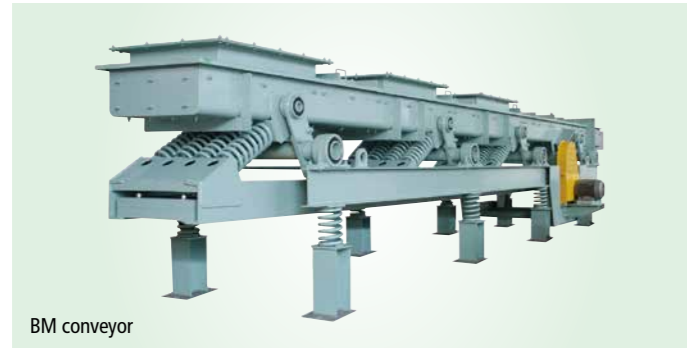

BM conveyor



MDC conveyor



MVCB conveyor



Sliding conveyor



RV conveyor



Rubber-spring conveyor

### ● Applications

Foodstuffs	● Ceramics	● Crushed stone	● Waste processing	●
Sugar refining	● Plastics	● Mining	● Vehicles	●
Feedstuffs	● Synthetic fibers	● Sanitary ware	● Machinery	●
Fertilizers	● Paper making	● Casting and forging	● Electrical equipment	●
Chemicals	● Tobacco products	● Asphalt	●	●
Glass	● Iron and steel	● Metals	●	●

# VIBRATING SCREENS

## Sifting and sorting suitable for any materials and uses

Vibrating screens are used for many different purposes: sorting by shape, sorting into grain sizes, eliminating foreign matter, preparing material for later processing, and so on. The types of screens in use are becoming more diverse, reflecting the different shapes, properties and flow characteristics of the materials they are used with, as well as the different environments and ways in which they are used.

We produce vibrating screens in 10 series, using various types of vibration: electromagnetic, eccentric-crank, direct vibration from a vibrating motor, horizontal swivel vibration, etc. Responding to calls for enhanced and more efficient processing of particulate materials, we can supply the optimal screening equipment to suit any purpose and any materials, from fine powder to lumpy matter, by bringing together the appropriate mesh size, processing capacity and type of vibration.

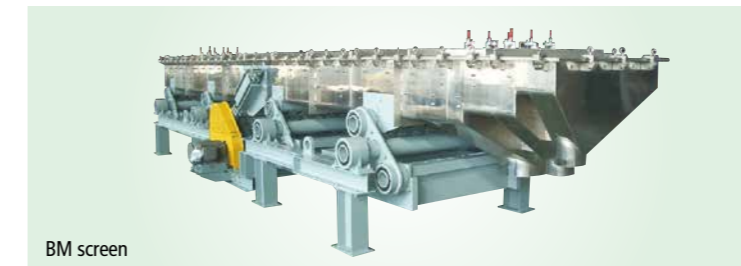

BM screen

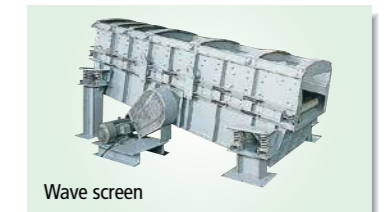

Wave screen



RV screen

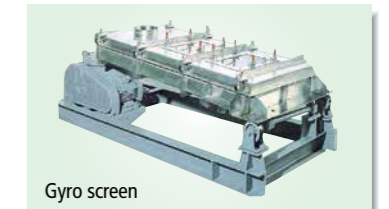

Gyro screen

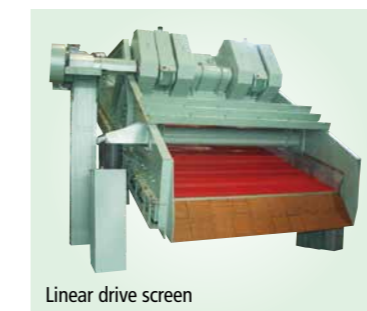

Linear drive screen

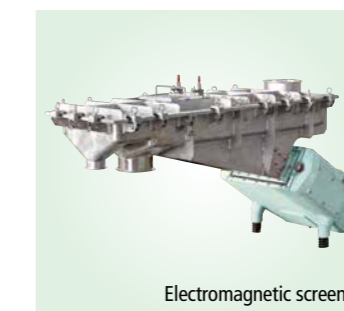

Electromagnetic screen



Shakeout machine

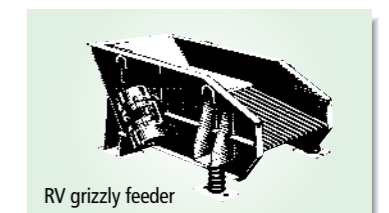

RV grizzly feeder

### ● Applications

Foodstuffs	● Ceramics	● Crushed stone	● Waste processing	●
Sugar refining	● Plastics	● Mining	● Vehicles	●
Feedstuffs	● Synthetic fibers	● Sanitary ware	● Machinery	●
Fertilizers	● Paper making	● Casting and forging	● Electrical equipment	●
Chemicals	● Tobacco products	● Asphalt	●	●
Glass	● Iron and steel	● Metals	●	●

# VIBRATING FEEDERS

## Swift and precise feeding of all sorts of particulates

Vibrating feeders serve a wide range of applications, from the fixed-quantity supply of granular materials to the control of flow for processing. We supply three basic types of feeders: electromagnetic feeders, rubber-spring feeders that generate vibration with a rotating unbalanced weight, and RV feeders that use vibrating motors. All of them feature outstanding performance in fixed quantity supply, due to high feed precision, as well as excellent cut-off characteristics and convenient control of supply quantity.

Whether it's a single unit, an assembly of units or a combination with weighing or other control devices, we can supply the ideal vibrating feeder to suit the grain size and characteristics of the material to be handled, and the supply quantity required, bringing greater precision, automation and streamlining to processing.



Rubber-spring feeder



Electromagnetic feeder (covered trough with mouth, outlet)

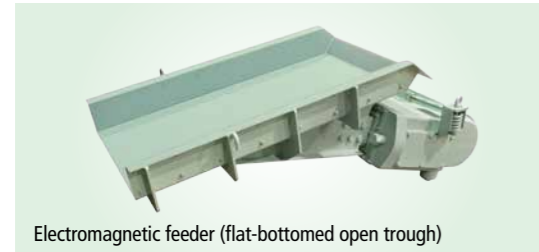

Electromagnetic feeder (flat-bottomed open trough)



Electromagnetic feeder (top drive type trough)



Electromagnetic feeder (trough with outlet)



Water-resistant Electromagnetic Feeder



Low floor long trough feeder



Sliding feeder

### ● Applications

Foodstuffs	● Ceramics	● Crushed stone	● Waste processing	●
Sugar refining	● Plastics	● Mining	● Vehicles	●
Feedstuffs	● Synthetic fibers	● Sanitary ware	● Machinery	●
Fertilizers	● Paper making	● Casting and forging	● Electrical equipment	●
Chemicals	● Tobacco products	● Asphalt	●	●
Glass	● Iron and steel	● Metals	●	●

# VIBRATING DRYER-COOLER SYSTEM

## For drying and cooling during conveyance

Vibrating dryer-cooler system comprises a vibrating conveyor, cooling source, fan, and dust removal and extraction equipment. Vibration is used to generate material flow, and air driven through the base of the trough dries and cools the material evenly. By adjusting vibratory characteristics the conveyance/processing time can be freely selected for detailed and precise control of the material's final temperature and moisture content. Thus, the ideal drying and cooling processing can be obtained for different types of material, as well as different processing conditions and objectives.

Our equipment enjoys an excellent reputation in providing for high quality and high efficiency processing of this type in many fields: not only foodstuffs but chemicals, feeds, synthetic resins, ceramics, and more.

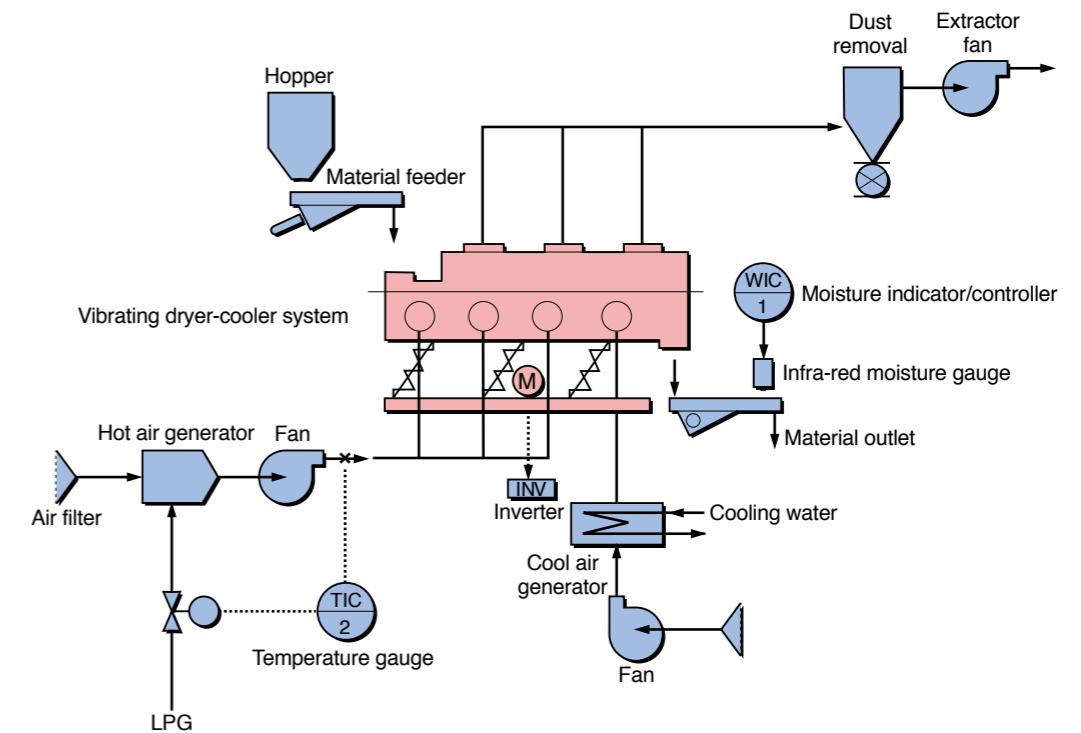

RV type



BM type

### ● Applications

Foodstuffs	● Ceramics	● Crushed stone	Waste processing	
Sugar refining	● Plastics	● Mining	Vehicles	
Feedstuffs	● Synthetic fibers	● Sanitary ware	● Machinery	
Fertilizers	● Paper making	● Casting and forging	● Electrical equipment	
Chemicals	● Tobacco products	● Asphalt	●	
Glass	● Iron and steel	● Metals	●	



## Compact devices to assist particulate material processing

### Small electromagnetic feeders

These compact and highly accurate vibrating feeders have a variable frequency controller installed as standard to boost efficiency by eliminating the need for time-consuming leaf spring adjustment. With superior cut-off characteristics, they excel at the delivery, output and measured delivery of all sorts of particulate materials. Ideal for small quantities or, when combined with a weighing device, precise fixed quantities.



### Linear feeders

In these straight line conveyance feeders, the angle of vibration and amplitude can be modified at will by adjusting the angle of the two leaf springs positioned at each end of the device. This is the ideal conveyance for fine powders that scatter, materials that are easily damaged, or small parts that may bounce. They can be linked in series to move materials over longer distances, or used side by side in versatile configurations.



### Vibrators

High performance vibrators can be attached to hoppers, bins or chutes to eliminate blocking, arching, adhesion and clogging. We produce a series of models in each of three basic types, to give the optimal match with the application and material. Vibrators may also be used as a vibration source for many types of vibrating equipment.



### Flow control valves

Easily attached to the outlets of hoppers, bins and chutes, flow control valves control material flow by a sleeve opening or closing like a camera aperture. There are two basic types: manual, adjusted with a handle, and motor-driven, for automated control.



### Vibrating packers

A vibrating surface on which cans and jars can be filled swiftly and evenly with powder and granular materials, such as pharmaceutical products or chemicals. Once switched on, filling is instant and containers do not have to be attached in any way, so filling can proceed continuously.



### ● Applications

Foodstuffs	● Ceramics	● Crushed stone	● Waste processing	●
Sugar refining	● Plastics	● Mining	● Vehicles	
Feedstuffs	● Synthetic fibers	● Sanitary ware	● Machinery	
Fertilizers	● Paper making	● Casting and forging	● Electrical equipment	
Chemicals	● Tobacco products	● Asphalt		
Glass	● Iron and steel	● Metals	●	

## Delivering the tiniest components, from bolts to chips

From the latest mobile data communications devices to electrical appliances, machinery, foodstuffs and pharmaceuticals, the handling of components is a vital part of production lines in a wide range of fields. We bring to the task the quality products and advanced know-how of a leading manufacturer of parts feeders, aiming to increase efficiency in regulation and delivery of parts of all shapes and sizes, and supply of powder materials in very small quantities.

Furthermore, working from existing vibratory technology, we are researching new parts handling systems through the development of our own drive systems and manufacture of specialized controllers to address needs for faster, more accurate and more reliable automatic regulation and delivery.

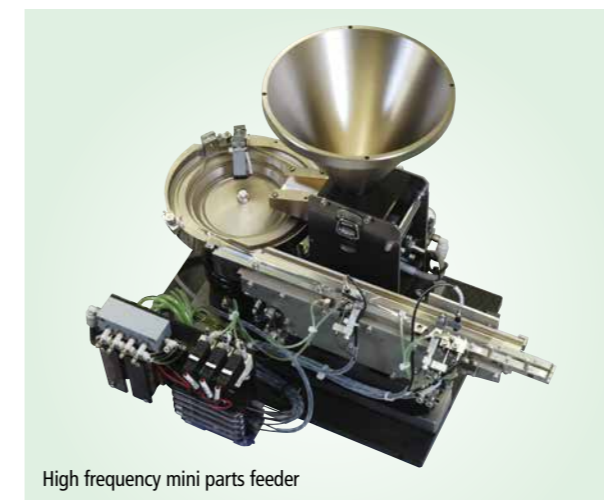

High frequency mini parts feeder



Dual motion parts feeder

Digital controller

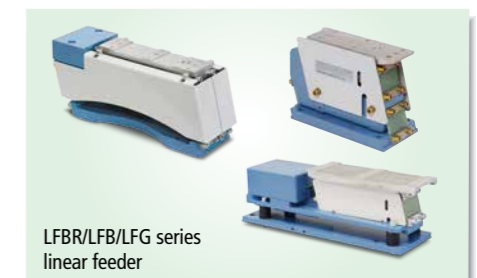

LFBR/LFB/LFG series linear feeder



EA/ER series parts feeder



Variable Frequency Digital controller C10 Series

### ● Applications

Foodstuffs	● Ceramics	● Crushed stone	Waste processing	
Sugar refining	● Plastics	● Mining	Vehicles	●
Feedstuffs	● Synthetic fibers	● Sanitary ware	Machinery	●
Fertilizers	● Paper making	● Casting and forging	● Electrical equipment	●
Chemicals	● Tobacco products	● Asphalt		
Glass	● Iron and steel	● Metals	●	



# PRODUCTION SYSTEM

## COFFEE PROCESSING PLANT

### Bringing experience and technology to coffee making

Our vibrating technology plays an important role in the production of fine flavored coffee. Changes in consumer preference have resulted in many different types of coffee, and demand continues to expand. Coffee processing facilities must become increasingly sophisticated to respond to consumers' diversifying preferences and make better coffee. We supply a comprehensive



coffee processing plant that uses vibrating equipment for its hoppers, conveyors, and cooling/drying processing. With 40 years' involvement in coffee processing, we bring together long experience and the latest technology to guarantee a full response to individual client's requirements and contribute to the production of rich tasting, and aromatic coffee.

### ● System flow diagram

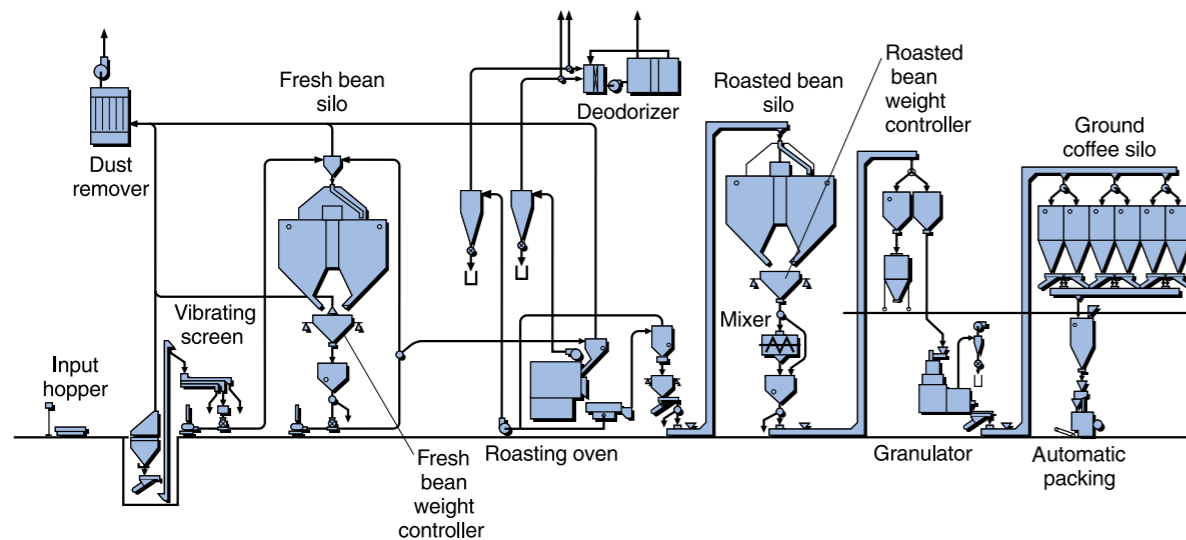

### History Vibrating Equipment Division

- 1917 ● A electrical machinery plant was founded at Toba Shipyard. The origins of SHINKO ELECTRIC.
- 1921 ● The plant becomes the Toba Plant of Kobe Steel Ltd.
- 1949 ● SHINKO ELECTRIC CO., LTD. splits off from Kobe Steel. Production of vibrating equipment starts at the company's Hino plant in Tokyo.
- 1965 ● Toyohashi Plant opens in Toyohashi, Aichi prefecture(now Toyohashi Works).
- 1978 ● Vibrating equipment production moved from Tokyo with the opening of a new vibratory equipment plant at Toyohashi Works.
- 1984 ● The Vibrating Equipment Technical Center built at Toyohashi a plant.
- 1989 ● THAI PARTSFEEDER CO., LTD. was founded in Bangkok, Thailand.
- 2004 ● Tokyo Head Office relocated to Minato Ward.
- 2008 ● THAI PARTSFEEDER CO., LTD. changed its company name to SINFONIA TECHNOLOGY (THAILAND) CO., LTD.
- 2009 ● Company name changed from SHINKO ELECTRIC CO., LTD. as of April 2009.
- 2011 ● Sales office of SINFONIA TECHNOLOGY (THAILAND)CO., LTD. opened in Bangkok, Thailand.
- 2012 ● Indonesia Representative Office was established in Jakarta, Indonesia.
- 2014 ● The Global Engineering & Development Center was opened at Toyohashi Plant.
- Indonesia Representative Office became local subsidiary, PT. SINFONIA TECHNOLOGY INDONESIA.
- 2017 ● 100 years anniversary

### Global Engineering & Development Center



With a skilled research and technical staff, and state-of-the-art testing facilities, we undertake basic testing of all types of particulate materials, and work towards developing new products, new technologies and new applications. Many types of vibrating equipment and cooling and drying processing equipment have been installed for accurate tests on material samples, and for performance and assessment testing.

The Center is responsible for the continuing development of our technology, and contributes to advances in particulate material processing by responding to individual customer's specialized needs.

### Experimental facilities



Test installation for vibrating drying and cooling processes



Vibrating conveyors and screens for testing purposes